

**OPERATION MANUAL**

**BF-030SPP/WPP**

**PLUS**

First of all, we would like to thank you very much for purchasing a Plus Copy board CONFERENCE MODEL.

Please read this Operation Manual before using the machine to get the best performance out of the product.

We recommend that you keep this manual for future reference.

## **EXPLANATION OF UL REGULATORY LABEL (USA ONLY)**

**PLEASE NOTE:** The description "Computer Rooms" on the label located on the rear of the copyboard, refers to areas where an abundance of computer control equipment (such as high output servers) is being used, It does NOT refer to environments such as offices or classrooms where there are simply PC's being used.

UL regulations require that we place a warning label in regard to this item being used in a "Computer Room". Please understand that this equipment will in no way interfere with the running of computer equipment or peripherals. The UL regulation simply applies to all items that contain flammable material in excess of a specified area, We would like to further stress that there is no inherent risk of this equipment causing a fire. It is only pointing out that should a fire occur, then this equipment will also burn along with any other flammable materials contained in the room.

Should you have any questions whatsoever about this information, please call PLUS Corporation of America directly at (201)818-2700

## ○———— **CONTENTS** —————○

FEATURES .....	1
SAFETY PRECAUTIONS .....	2
PRODUCT FEATURES .....	3
CONTROL FUNCTIONS .....	4
OPERATION .....	5
MAINTENANCE/STORAGE .....	10
HANDLING PRECAUTIONS .....	10
TROUBLE SHOOTING .....	11
SPECIFICATIONS .....	12

**Printer must be purchased separately.**

Compatible printer: HP LaserJet 6L, 6Lse, 6Lxi, 6MP, 6Pse, 6Pxi

\*Compatible printers are subject to change without notice.

Please call PLUS @ 1-800-289-7587 with question regarding printer compatibility.

\*PLUS BF-030PP plain paper electronic copy board dose not have a built-in thermal printer.

**FEATURES**

- The world's first plain paper printing electronic copy board with two built-in interface that let you print directly from the writing panc'l's surface to a compatible PC printer or download information to your personal computer.
- You can copy the information on the board surface quickly onto plain paper via the connected compatible PC printer.
- The plain paper does not discolor or fade like heat-sensitive paper, thus making copies unnecessary and saving both time and money.
- By connecting your PC to the board, you can download the information on the board surface and save it. Then, you can edit and send it via e-mail or network to other remote location.
- If a PC and compatible PC printer is connected to the port on the bottom of the board, it is possible to use the unit as a PC printer. (It is necessary to install the auxiliary driver software in the PC unit.)
- The board surface can be easily moved with a light manual touch.

**BF-030SPP BOARD FAX CARTON CONTENTS**

The product package contents are as listed below. Please confirm that all parts have been included before using the equipment.

Copy board ..... 1

**MAIN UNIT ACCESSORIES**

- Special markers (one each of black, red, blue)
- Special eraser (1)
- Instruction Manual (1 copy with Guarantee)
- Power cord (1 cord, 4 meters long)
- Printer power cord (2 cord, 1.1 and 2.5 meters long)
- Printer cable (1 cable, 1.3 meters long)

**BOARD WARE ACCESSORIES**

- Interface cable (D-Sub 9 pin, 2 m): 1
- Set-up disk (floppy disk): 1
- Set-up manual: 1 copy
- User registration card: 1

**Note:** HP LaserJet 6L, 6Lse, 6Lxi, 6MP, 6Pse, 6Pxi and Extension PCL 5 are trademarks of Hewlett-Packard Company in the United States. MS-DOS, Windows, Windows 3.1, and Windows 95 are registered trademarks of Microsoft Corporation in the United States and in other countries. All other product names and company names are the registered trademarks or trademarks of the respective companies.

# SAFETY PRECAUTIONS

## Before use (picture displays).

Please read this manual carefully before using your board-Fax BF-030SPP/WPP and keep the manual handy for future reference.



### CAUTION

TO PREVENT SHOCK, DO NOT OPEN THE CABINET. NO USER-SERVICEABLE PARTS INSIDE. REFER SERVICING TO QUALIFIED PLUS SERVICE PERSONNEL.

### WARNING

TO PREVENT FIRE OR SHOCK, DO NOT EXPOSE THIS UNIT TO RAIN OR MOISTURE. DO NOT USE THIS UNIT'S GROUNDED PLUG WITH AN EXTENSION CORD OR IN AN OUTLET UNLESS ALL THREE PRONGS CAN BE FULLY INSERTED. DO NOT OPEN THE CABINET. THERE ARE HIGH-VOLTAGE COMPONENTS INSIDE. ALL SERVICING MUST BE DONE BY QUALIFIED PLUS SERVICE PERSONNEL.

### WARNING

TO PREVENT FIRE OR SHOCK, DO NOT EXPOSE THIS UNIT TO RAIN OR MOISTURE. DO NOT USE THIS UNIT'S GROUNDED PLUG WITH AN EXTENSION CORD OR IN AN OUTLET UNLESS ALL THREE PRONGS CAN BE FULLY INSERTED. DO NOT OPEN THE CABINET. THERE ARE HIGH-VOLTAGE COMPONENTS INSIDE. ALL SERVICING MUST BE DONE BY QUALIFIED PLUS SERVICE PERSONNEL.

# PRODUCT FEATURES

## Back Side

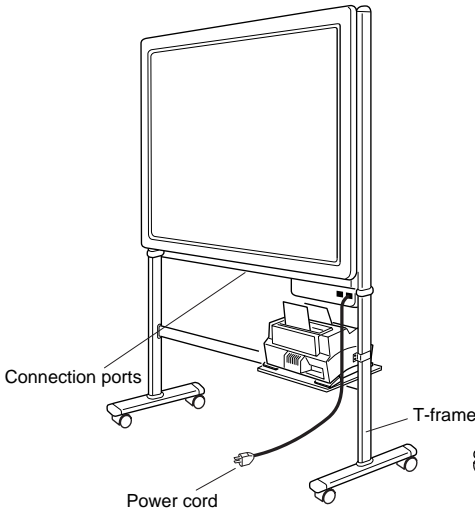

## Front Side

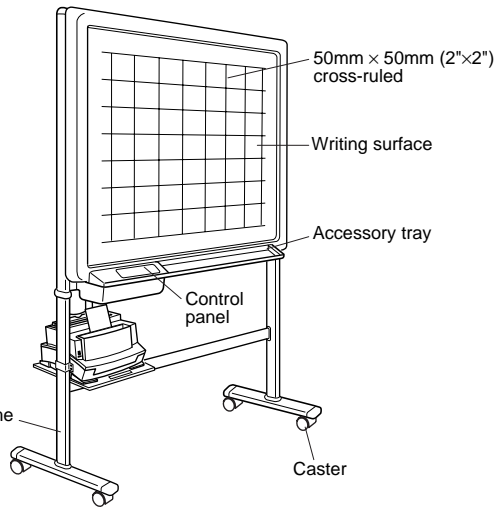

**NOTE:** Printer not included. Printer must be purchased separately.

Compatible printer: HP LaserJet 6L, 6L, 6Lse, 6Lxi, 6MP, 6Pse, 6Pxi

\*Compatible printers are subject to change without notice.

Please call PLUS @ 1-800-289-7587 with question regarding printer compatibility.

\*PLUS BF-030PP plain paper electronic copy board does not have a built-in thermal printer.

## Connection ports

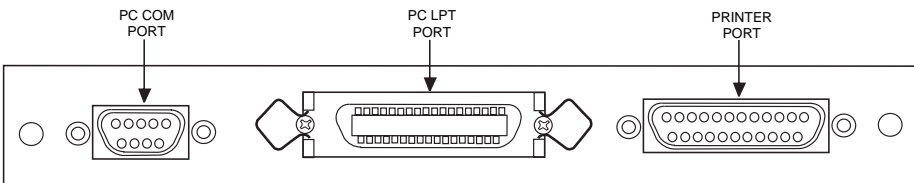

# CONTROL FUNCTIONS

## CONTROL PANEL

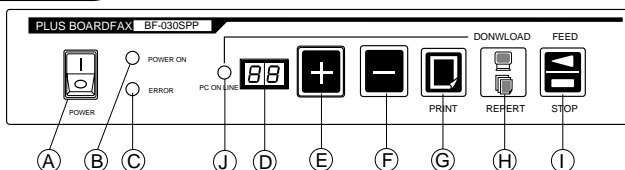

- A Power Switch** ..... Pushing to the " I " (ON) side causes the power to go ON. "01" is displayed in the LED panel.
- B Power lamp** ..... The lamp (green) goes on when the switch is turned on.
- C Error lamp** ..... Lights (red) when a printer error occurs. Blinks when the copy key is pressed while sending data from the PC.
- D LED panel** ..... Displays the number of copies. The number of copies is set with the + and - keys.  
If there is no key operation for more than 1 minute, the display changes to the "01" display.
- E + key**
- F - key** ..... Used to set the number of copies.  
Press the + key to increase the number of copies. By keeping the key pressed down, you can increase the number of copies automatically up to "99".  
Press the - key to decrease the number of copies. By keeping the key pressed down, you can decrease the number of copies automatically down to "01".  
It is possible to set for up to 99 copies.
- G Print key** ..... Use this key to print one page on the writing surface to paper.  
BF-030SPP: The copy has the same compression ration vertically and horizontally.  
BF-030WPP: The copy is compressed horizontally.
- H Download/Recopy key** ..... This key is used to make a print-out again after copying.  
The +/- keys can be used.  
If the PC On-Line lamp is lit, the Boardware software can be used to download the writing surface data to the PC.
- I Feed/Stop key** ..... Used to move the writing surface to the left. When the key is pressed, it moves 1 page and stops automatically. If the key is pressed again while the writing surface is moving, it stops immediately. If this key is pressed during copying, the writing surface is stopped and the paper is ejected during printing.
- If the number of copies is set to multiple copies, the printer will eject the set number of page for the paper which were printed on up to the point when the stop key was pressed. Reset the printer. See page 7 for the method of resetting the printer
  - Do not turn the power switch OFF during printing.  
If the power switch is turned OFF by mistake during printing, this could cause a paper jam.
- J PC ON-Line lamp** ..... This lamp is lit when the Boardware software is used and the unit is connected to a PC.

# OPERATION

The following is the explanation of operation assuming an HP LaserJet 6L is being used as the printer.

If any other compatible printers are to be used, please see the operation manual for that particular.

\*Please see Page.1 for compatible printers.

## ■ Before Use

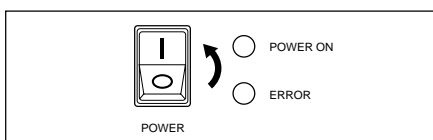

- ① Press the caster lock switches to set the casters to the lock position.
- ② Insert the power cord plug in the socket.
- ③ Turn the power switch ON. The power lamp blinks 2-3 seconds and then remains lit (green).



After all the lamps light on the printer front panel, the lamps immediately light in the order of data lamp (center), error lamp (top) and on-line lamp (bottom).

If there is no paper in the unit, the error lamp (top) remains lit. Insert paper in the required location.

### Printer Display Lamps (HP LaserJet 6L)

-  • Error (yellow)
-  • Data (green)
-  • Printing OK (green)

## ■ Paper Insertion

- ① Pull up the paper support attached to the back of the printer paper feed tray.
- ② Insert paper in the paper feed tray. Up to 100 sheets can be inserted at a time. Make sure that no paper is protruding from the paper feed tray at this time. If paper is inserted in the paper feed tray, the on-line lamp (bottom) is lit.
- ③ Use the paper guide to locate center the paper in the feed tray.

\* For further details, consult the Operation Manual for the printer.

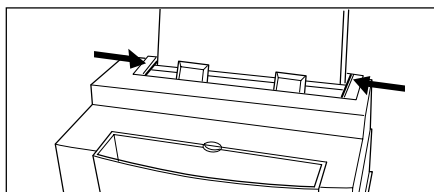
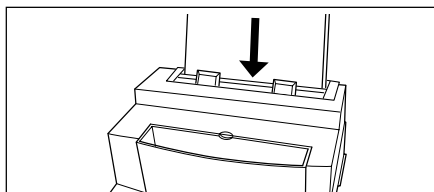
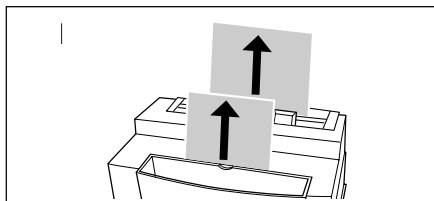

# OPERATION

## ■ Selecting the Paper Path

- Operate the paper path lever on the lower left side up the front of the printer to select the paper path.
- Pushing the lever up causes the paper to be ejected in the tray on the top.
- Pushing the lever down causes the paper to be ejected from the front of the printer.
- \* Do not operate the lever during copying as this could cause paper jams.
- \* If there are many copies, to be printed use the paper eject tray on the top.

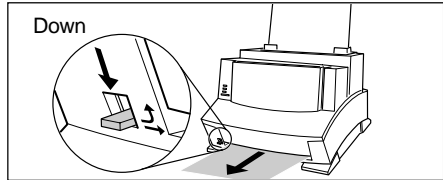
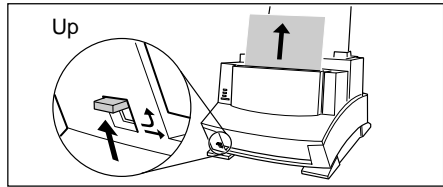

## ■ Attaching the toner cartridge

To attach the toner cartridge, first remove the toner cartridge from the package. (Keep the package in a safe place for re-storage of the cartridge).

- ① Hold the cover with both hands and pull toward you to open.
- ② Shake the toner cartridge well to evenly distribute the toner in the cartridge.
- ③ Hold the ends of the sealing tape attached to the side of the cartridge and pull it to completely remove the tape from the cartridge. The length of the tape after removal is 490 mm (19.3 inches) or twice the length of the cartridge.
- ④ While grasping the handle on the cartridge (so that the arrow is facing the printer side), insert the cartridge in the printer. Be sure that the ends of the cartridge match the groove on the black plastic section. Insert the cartridge all the way to the back and close the printer cover.

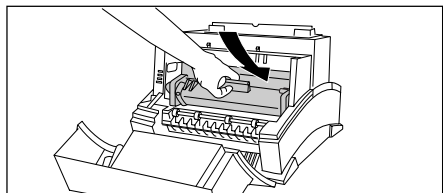
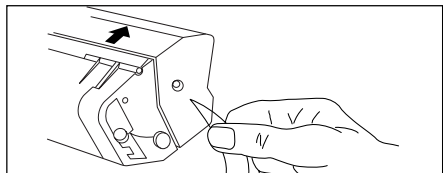
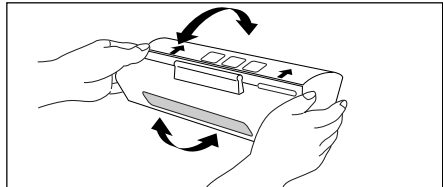
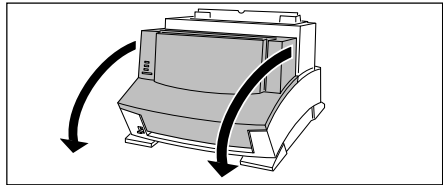

## ■ Operation

- Use the special markers to write on the board.

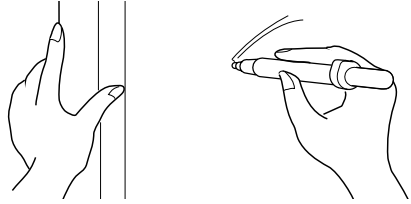

## ■ Making Copies

### ● Making a single copy.

Press the Copy key.

The writing surface moves the equivalent of one side and the contents are copied onto paper.

- \* When making a single copy it is not necessary to set the number of copies.

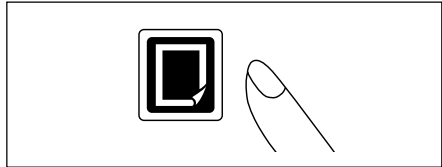

### ● Making multiple copies.

Use the +/- keys to set to the required number of copies.

Press the Copy key.

The writing surface moves the equivalent of one side and the contents are copied on multiple sheets of paper.

- \* It is possible to set to up to 99 copies.

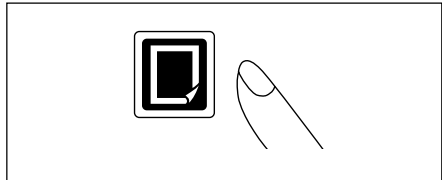

### ● Stopping copying operations midway.

Press the Feed/Stop key.

The writing surface being read stops.

The pages which was being printed on is ejected from the printer.

- \* If the unit has been set to multiple copies, the sheets that were printed up to that point are ejected for the set number of copies.

Remove all the inserted paper at this time and reset the printer.

- \* Resetting the printer.

Hold down the printer front panel button (approx. 5 seconds) and release the button after the 3 display lamps light in order.

- \* If the printer is being reset, it is not possible to receive key operations while the copy count display is blinking.

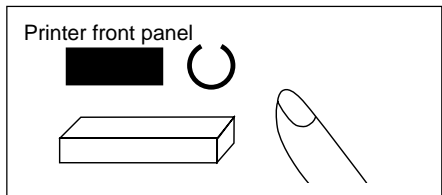
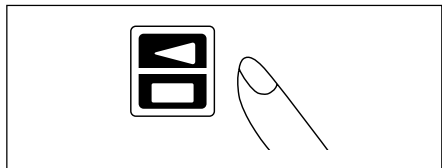

# OPERATION

## ■ Making Additional Copies (Repeat)

### ● To make a single copy

Press the Repeat key.

The 1 additional sheet is printed out from data that was just copied.

\* There is no need to set several sheets when making only 1 copy.

### ● To make additional copies

Set the number of copies needed with the [+] or [-] keys.

Press the Repeat key.

The copies are printed out from data that was just copied.

\* A maximum of 99 copies can be set.

\* The Stop key is disabled during printout.  
Be sure to set the correct number of copies.

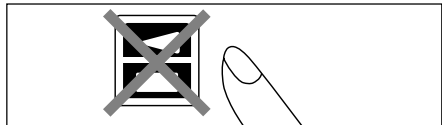
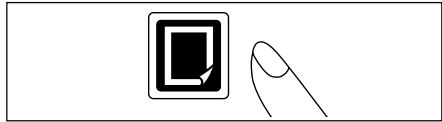
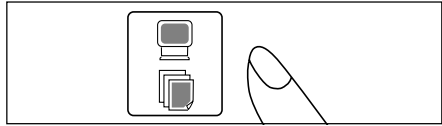

## ■ Moving the writing surface

### ● Moving with the keys.

Press the Feed/Stop key. When the key is pressed, the writing surface moves to the left the equivalent of one page and then stops. If the Feed/Stop key is pressed during movement, the unit immediately stops.

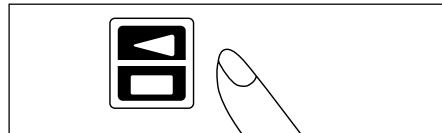

### ● Moving manually

It is also possible to move the writing surface manually. The sheet can be moved in this case either to the left or right. Avoid moving the writing surface too quickly manually as this could cause malfunctioning.

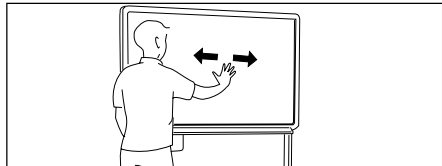

## ■ Downloading data to the PC

● Use the auxiliary cable to connect the COM Port on the PC and the PC COM connector (9 pins) on the board to the auxiliary serial cable.

● Install the board ware software in the PC.

● Use the board ware software to download the writing surface data to the PC.

\* The PC ONLINE lamp on the unit switch panel lights up when the boardware starts up and the "Repeat" key changes to the "Download" key. The Repeat function is now inoperable.

\* Consult the board ware software manual for the connect installation and operation of the software.

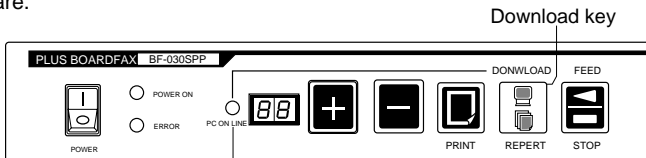

## ■ Printing of PC data

- Use the printer cable to connect the PC printer connector and the, PC LPT connector of the board.
- Install the printer driver in the PC.
- Use the PC applications to print to the printer.
  - \* A PC printer cable is not included with this equipment.  
Please use a printer cable conforming with IEEE regulations.
  - \* Consult the printer manual for the method of installing the driver.
  - \* The accessory driver software for the printer is for Windows and cannot be connected to a Macintosh.

### Connection ports

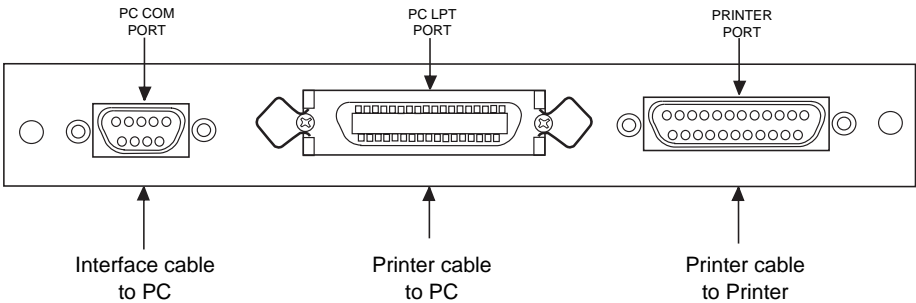

### PLUS COPYBOARD

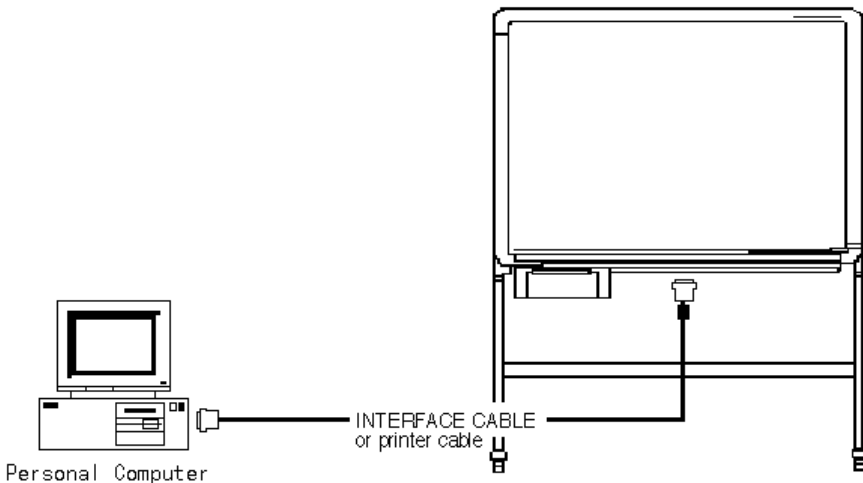

# MAINTENANCE/STORAGE

Conduct regular maintenance as described below to insure clear copies at all times.

(1) Cleaning the writing surface.

If the writing surface is dirty, use a damp cloth to clean it off. In case of severe build-up, use a neutral cleaner diluted in water. Be sure the sheet is completely dry before operating the equipment again.

(2) Cleaning the accessory tray and frame.

Use a damp cloth to clean off any residue from markers on the accessory tray and frame.

# HANDLING PRECAUTIONS

## <FOR SAFE USE>

1. Avoid placing the board in hot or cold areas where it is exposed to direct sunlight or next to an air conditioning duct.
2. When using sticky tape on the surface of the writing surface to attach paper originals, be sure to remove it at once when finished. Moreover, after removing it, wipe the writing surface clean.  
Do not hit or pierce the panel with any hard or sharp objects.
3. Do not leave writing or marks on pages 1-4 for a long time since it may become difficult to erase.
4. As thinner, benzine, alcohol, etc., may discolor or mark the main unit and the writing surface never use such chemicals when cleaning.
5. After use, be sure to turn OFF the power switch. In addition, when it is not to be used for a long time, make certain that the plug is pulled from the outlet.
6. Always use the correct type of marker. Be careful not to use other markers as the panel may be damaged or, in some cases, the ink may be difficult to remove.
7. To ensure all information will be printed, leave a slight margin around the edge of the panel as indicated below.

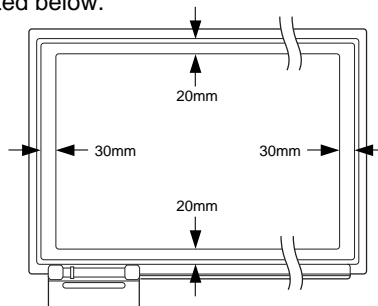

8. When moving this machine, disengage the caster locks, hold both the right and the left sides of the main unit firmly, and avoid any sudden jolts or shocks.

# TROUBLE SHOOTING

## BEFORE CALLING FOR HELP, TRY ....

PROBLEM	CHECKPOINT
<b>POWER WONT TURN ON</b>	<ul style="list-style-type: none"><li>• Check if power cord is connected to outlet (plug socket).</li></ul>
<b>WONT COPY EVEN BY PRESSING COPY KEY</b>	<ul style="list-style-type: none"><li>• Check if printer power cord or printer cable has been disconnected.</li><li>• Check if error lamps on the printer or main unit are lit up. (If these are lit up, try turning the power off temporarily and then turning it back on again.)</li></ul>
<b>WHEN SHEET WRITING CAN'T BE REMOVED WITH ERASER</b>	<ul style="list-style-type: none"><li>• Was writing done with other than the special markers? (Gently wipe away with a cloth soaked in water or neutral detergent and thoroughly wrung out.)</li></ul>
<b>COPIES HAVE STAINS OR SMEARS</b>	<ul style="list-style-type: none"><li>• Are many small pieces from the marker stuck to the sheet? (When dirty or stained gently stroke the sheet surface wiping dirt away gently with a soft cloth soaked in water and then well wrung out.)</li></ul>

- Refer to the separate printer manual when printer related problems occur.

## WHEN THIS HAPPENS .....

<b>WHEN PRINTER OPERATION DOESN'T MATCH SHEET OPERATION</b>	<ul style="list-style-type: none"><li>• The sheet may sometimes pause for a while when many entries have been made and printer operation cannot keep up.</li></ul>
<b>WHEN THE COPY IS SLIGHTLY BLURRED</b>	<ul style="list-style-type: none"><li>• When the sheet has paused, the copy at the portion may deviate slightly from position.</li></ul>

- If no satisfactory result can be achieved even after the above, contact the suppliers or our company.

# SPECIFICATIONS

Configuration		BF-030SPP	BF-030WPP
Board section	Writing surface size	920 (H) × 1300 (H) mm 36 × 51 inch	920 (H) × 1800 (H) mm 36 × 70 inch
	Effective reading size	880 (H) × 1240 (H) mm 34 × 48 inch	880 (H) × 1740 (H) mm 34 × 68 inch
	Number of pages	2 pages	
	Screen drive method	Unidirectional endless drive method	
	Feint lines	50 mm (2"≒2") cross-ruled	
	Writing tools	Special markers (black, red, blue)	
	Reading method	CCD sensor flat surface scan reading	
Control section	Main unit	Power source switch, copy, number of copies (+)(-), feed/stop download/recopy	
Display section	Main unit	Power lamp, error lamp, LED panel (PC ON LINE LAMP)	
Usage conditions	Power source	North America	120V AC 60Hz
		Europe	230V AC 50Hz
	Asia/Oceania	220-240V AC 50Hz	
	Central South America	Middle/Near East Respective rated local voltage/frequency (110V, 120V, 220-240V)	
	Temperature	5-35 degrees C	
	Humidity	30%~85% (without dew condensation).	
External dimensions	T-frame set	1470 (W) × 600 (D) × 1885 (H) mm 57 × 23 × 74 inch	1970 (W) × 600 (D) × 1885 (H) mm 77 × 23 × 74 inch
Weight	Main unit + legs + printer platform	41.6kg	46.6kg

\* Product specifications and external appearance are subject to change without prior notice.

## Power Save Function

If there has been no key operation for approximately an hour, the fluorescent lamp in the unit interior automatically turns off and enters the power save state. The power lamp is lit during this time.

If any key is pressed, the fluorescent lamp lights again and the unit returns to the normal state.

# **PLUS CORPORATION**

3-B22, NAKASE 1-CHOME, MIHAMA-KU, CHIBA 261-8501 JAPAN

PHONE: 043-296-3056 FAX: 043-296-3025

TELEX: J22113 PLUSJIM, CABLE PLUSJIMUK TOKYO