

OPERATION MANUAL

BF-030W

PLUS

First of all, we would like to thank you very much for purchasing a Plus Board Fax CONFERENCE MODEL.

Please read this Operation Manual before using the machine to get the best performance out of the product.

We recommend that you keep this manual for future reference.

EXPLANATION OF UL REGULATORY LABEL (USA ONLY)

PLEASE NOTE: The description "Computer Rooms" on the label located on the rear of the copyboard, refers to areas where an abundance of computer control equipment (such as high output servers) is being used, It does NOT refer to environments such as offices or classrooms where there are simply PC's being used.

UL regulations require that we place a warning label in regard to this item being used in a "Computer Room". Please understand that this equipment will in no way interfere with the running of computer equipment or peripherals. The UL regulation simply applies to all items that contain flammable material in excess of a specified area, We would like to further stress that there is no inherent risk of this equipment causing a fire. It is only pointing out that should a fire occur, then this equipment will also burn along with any other flammable materials contained in the room.

Should you have any questions whatsoever about this information, please call PLUS Corporation of America directly at (201)818-2700

CONTENTS

FEATURES	1
PRODUCT FEATURES	2
CONTROL FUNCTIONS	3
HOW TO USE	4
MAINTENANCE/HOW TO STORE	7
HANDLING PRECAUTIONS	7
CHECK LIST OF SIMPLE FAILURES	8
SPECIFICATIONS	9

BF-030W BOARD FAX CARTON CONTENTS

Please be sure all of the following items are included in the carton with the BF-030W BOARD FAX

Board Fax main unit..... 1

ACCESSORIES

- Set of Dry-eraseable markers (one each black, red and blue).
- Dry-Eraser (1)
- Fax Paper (30m(96ft) , 12mm(w/1/2") core)
- Operation Manual with warranty card

OPTIONAL ACCESSORIES

- PC interface board - to enable integration of the BF-030W and your Personal Computer

FEATURES

- The board size is W1800mm × H920mm-large enough to show all the ideas that you discuss during your meetings, without any omissions.
- Information on the large screen can be copied immediately onto a sheet of A4/Letter paper. Those who attend a meeting can concentrate on the subject, as there is no need to waste time jotting down notes.
- The board screen can be slid easily, and, the powder tray is designed for easy disposal of powder.
- The BF-030W can be easily upgraded for use with your PC (with optional PC interface board)

PRODUCT FEATURES

FRONT

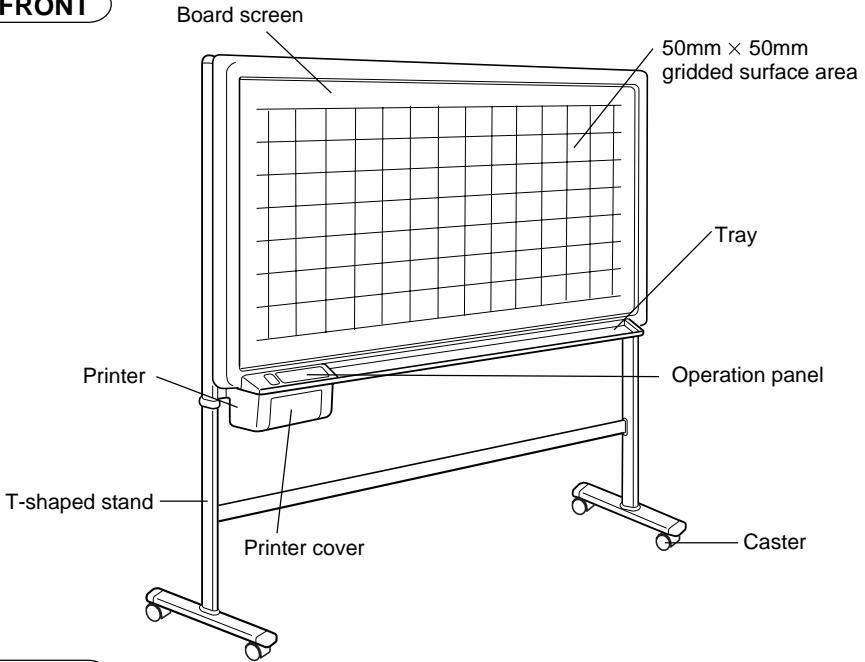

REAR

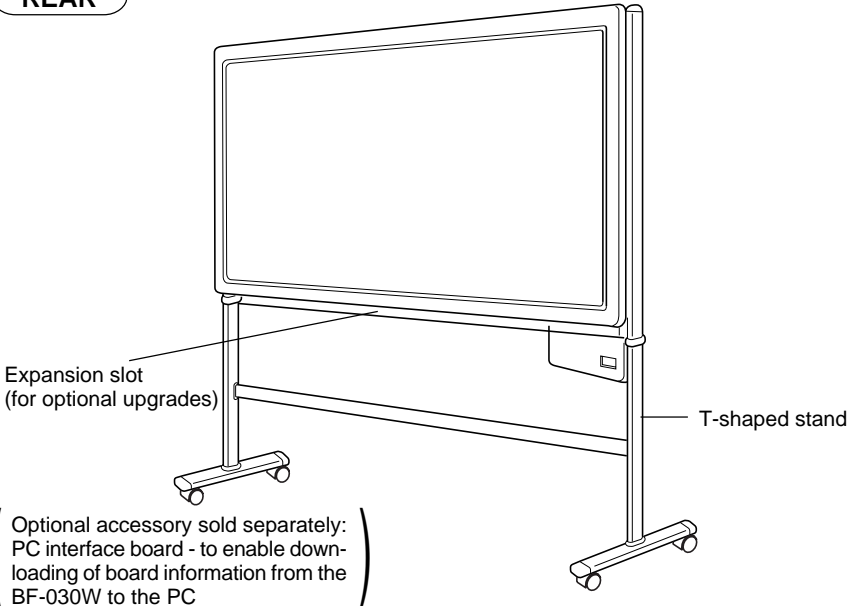

(Optional accessory sold separately:
PC interface board - to enable down-
loading of board information from the
BF-030W to the PC)

CONTROL FUNCTIONS

OPERATION PANEL

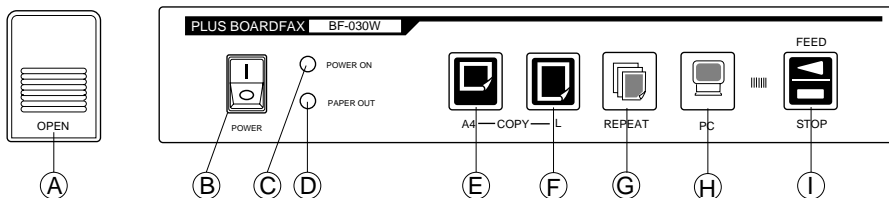

- (A) Opening button** Press this button to open the printer hatch when replacing the thermal paper.
- (B) Power switch** Press "I" to turn ON the power when starting machine operation.
- (C) Power lamp** Press the switch, and the green lamp will blink on and off. The lamp will stay lit (green) when the read sensor inside the machine is ready for operation.
- (D) Paper warning lamp** When the thermal paper has run out, the red lamp will light. Load new recording paper.
- (E) A4 reduction copy key** This is used when copying one page of the screen at a reduced size onto A4 paper. At this time, the copy is reduced horizontally.
- (F) A4-L copy key** This is used when one page of the screen is copied onto A4-L paper. The machine produces a copy at a reduced scale of the same length and breadth.
- (G) Repeat key** For use with optional PC interface kit.
- (H) PC COPY key** For use with optional PC interface kit.
- (I) Feed/stop key** This is used when the screen slides to the left. Pressing this key advances the screen by one page and then automatically stops. Pressing the key while the board screen is being moved stops it immediately. This can also be used when paper has run out and must be refilled. If this key is pressed during the copying operation, the copying performance ends and the printer stops.

HOW TO USE

■ BEFORE USE...

Press the caster lock switches ON and keep the casters in a locked position.
Plug in and turn ON the power switch. After the power lamp blinks for 2-3 seconds, it should turn green.

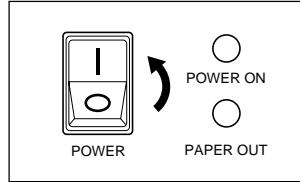

■ WHEN COPYING...

When copying onto A4 paper:

Press the A4 reduction copy key. At this time the board screen slides forward one page and the written contents are reduced onto A4 paper.

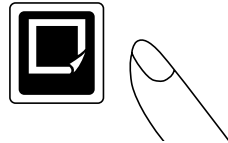

When copying onto A4-L paper:

Press A4-L copy key. At this time the board screen slides forward one page, and the written contents are reduced to A4-L size (210 x 400mm) and copied.

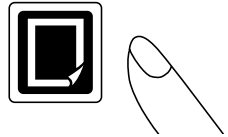

Cut-off of Recording Paper

When copying is completed, pull the tip of the recording paper upwards and cut it off with the edge of the outlet.

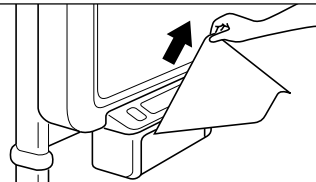

Halt of Copying

Press the feed/stop key to halt the copying operation immediately. The printer stops after completion of copying up to that point.

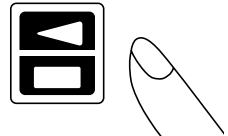

■ WHEN SLIDING THE SCREEN FORWARD...

Sliding by using key

Press the feed/stop key. Then, the board screen slides to the left by one page and stops. It stops immediately when the feed/stop key is pressed during the sliding operation.

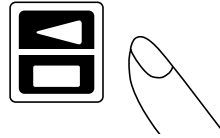

Manual sliding

It is also possible to slide the board screen manually. In this case, it can be slid in either direction; to the right and left. However, manual sliding at an excessively high speed must be avoided as it occasionally causes problems.

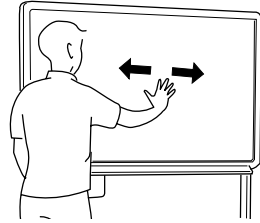

■ WHEN REPLACING RECORDING PAPER...

*Concerning replacement of recording paper

Replace with new recording paper in the following cases:

When a red line appears at the end of the recording paper.

(A red line appears when only about one meter or so of recording paper is remaining.)

When the paper warning lamp lights red.

1. Press the opening button to open the printer cover.

Take out the winding core of used recording paper.

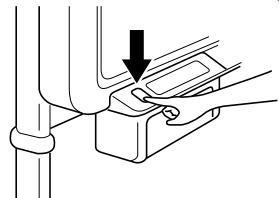

2. As illustrated, set it in so that the tip of the new roll of recording paper extends about 20cm from the outlet.

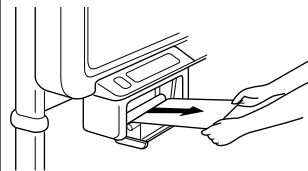

HOW TO USE

- 3.** Push both ends of the hatch closed until it locks with a clicking noise. At this time, make sure that the recording paper has not slipped.

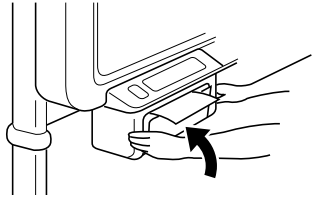

- 4.** Cut off the extra recording paper from the printer outlet.

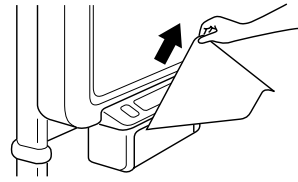

Replace the recording paper in the following situations

- When a red line appears at the edges of the recording paper. The red line will appear when there is only about one meter (3 feet) or so of recording paper left on the roll.
- When the paper out lamp lights red.

Note:

- Please use only the correct type of recording paper.
- Particular attention must be given to the winding direction of the recording paper, since copying cannot be performed if the winding direction of the recording paper is reversed.
- Be sure to keep the recording paper straight when loading, failure to do so may cause wrinkling or tearing of the paper during the copy function.

*Automatic Power Cut-off Function

If there is no key operation for about an hour, the fluorescent lamp inside the main unit automatically goes off and the machine enters a state of power conservation. (At this time, the power lamp is lit.)

If at any time any key is pressed, the fluorescent lamp light again, and the normal operating condition is restored.

MAINTENANCE/HOW TO STORE

Carry out the following maintenance procedures periodically to ensure high quality copying performance at all times.

(1) Cleaning of the surface

When the surface gets stained, wipe it off with a slightly damp cloth. Also, if the stain is particularly stubborn, use a solution of water-thinned neutral detergent to wipe it off. Do not start using the machine until the sheet has completely dried.

(2) Cleaning of tray and decorative frame

Wipe away any dirt or residue left by the markers in the tray and the decorative frame with a slightly damp cloth.

HANDLING PRECAUTIONS

<FOR SAFE USE>

1. Avoid placing the machine in hot spots where it is exposed to direct sunlight or where an air conditioning duct.
2. When using sticky tape on the surface of the board screen, do not leave it on for a long time. Moreover, after removing it, wipe the screen clean. Do not hit or pierce the board screen with any hard or sharp objects.
3. Do not leave writing or marks on the board screen for a long time since it sometimes become difficult to erase.
4. Be careful not to stain the joints of the board screen as there have been very rare cases where such stains have been copied.
5. As thinner, benzine, alcohol, etc., may discolor or mark the main unit and the board screen, never use such chemicals when cleaning.
6. Use only the correct type of recording paper.

When storing thermal recording paper, avoid the following places. This is important because storage in such places may cause color development or discoloration.

- (1) Places where the paper is exposed to direct sunlight.
- (2) Places where the paper is exposed to temperatures of more than 35°C and humidity of 85% or over.
- (3) Places adjacent to alcohol, thinner, benzine, ammonia, etc.

HANDLING PRECAUTIONS

7. When replacing recording paper, do not place any objects on the open printer cover or do not put your elbows on it.
8. After use, make sure to turn OFF the power switch. In addition, when it is not to be used for a long time, make certain that the plug of the power cord is pulled out from the outlet.
9. Always use the correct type of marker. Be careful not to use other markers as the sheet may be damaged or, in some cases, the ink may be difficult to remove.
10. Write within an area of a size that can be easily read.

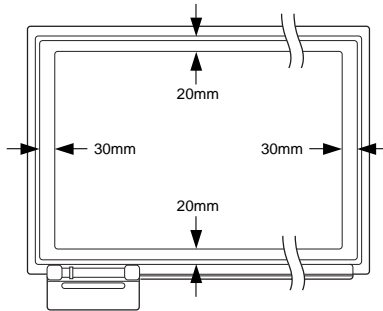

11. When moving this machine, turn OFF the caster lock switches, hold both the right and the left sides of the main unit firmly, and avoid any sudden jolts or shocks.

CHECK LIST OF SIMPLE FAILURES

<BEFORE ASKING FOR A REPAIR SERVICE>

CONDITIONS	CHECKPOINTS
When the power fails	Check if power cord is pulled out outlet.
When pressing copy key does not result in copying	Check if paper warning lamp (red) is lit.
Although printer is functioning, nothing is copied on recording paper	Check if winding direction of recording paper is set on reverse. (No copying is made on back of recording paper)
When characters written on board screen cannot be rubbed out even by the use of an eraser	Check if any marker except the correct type has been used. Wipe off with a damp cloth or neutral detergent.
When copy is dirty	Check for ink residue on the screen. If it is stained, wipe off carefully with a soft damp cloth.

* If no satisfactory result can be achieved even after the above, contact the suppliers or our company.

SPECIFICATIONS

Item	Specification	
Board surface size	W1800 × H920 mm (71 × 36 inch)	
Effective reading size	W1740 × H880 mm (68-1/2 × 34-3/4 inch)	
Number of pages	2 pages	
Screen driving method	One direction endless drive	
Grid	50mm squares	
Writing instruments	Special markers (black/red/blue)	
Reading method	CCD sensor, plane scanning	
Recording method	Thermal printing with thermal head	
Recording density	8 dot/mm	
Recording paper	Special thermal sensitive paper (30 m roll)	
Size of recording paper	A4 size (210 × 297mm) Letter size (8-1/2 × 11 inch)	
Recording color	Black	
Recording speed	1-surface copy: 15 sec/copy	
Operating conditions	Temperature: 5-35°C Humidity: 30-85% (Without dew condensation)	
Power source	North America 120V AC 60Hz Europe 230V AC 50Hz Asia/Oceania 220-240V AC 50Hz Central South America Middle/Near East Respective rated local voltage/frequency (110V, 120V, 220-240V)	
Power consumption	60W at stand-by, 120W at operation	
Outer dimensions	W1970 × D600 × H1885 mm(77-4/8 × 23-5/8 × 74-2/8 inch)	
Weight	46 kg	
Others	Consumables	Special thermal recording paper (30-m roll/98FT) Special markers Special eraser
	Optional Accessory	PC interface kit

*Specifications are subject to change without notice for improvement.

Placing this unit next to equipment or buildings (such as broadcasting stations) where strong RF interference is generated may sometimes cause printing to become blurred or disordered when copies are made. This does not indicate a breakdown or problem in this unit.

PLUS CORPORATION

3-B22, NAKASE 1-CHOME, MIHAMA-KU, CHIBA 261-8501 JAPAN

PHONE: 043-296-3056 FAX: 043-296-3025

TELEX: J22113 PLUSJIM, CABLE PLUSJIMUK TOKYO